

1 HEAD DETAIL
SCALE: FULL

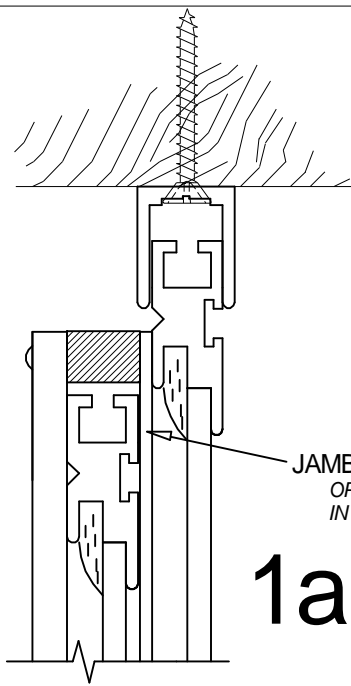

1a HEAD DETAIL
SCALE: FULL

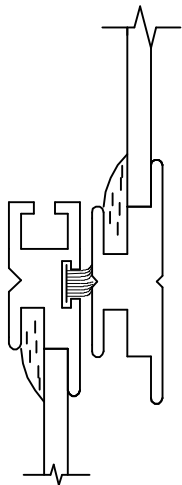
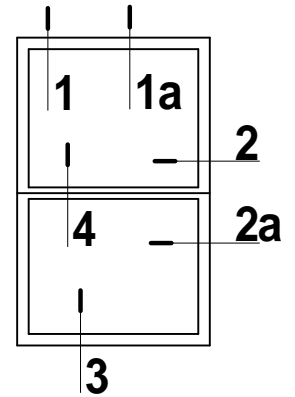

4 MEETING RAIL DETAIL
SCALE: FULL

OPERATING SASH SHOWN IN FULLY CLOSED POSITION

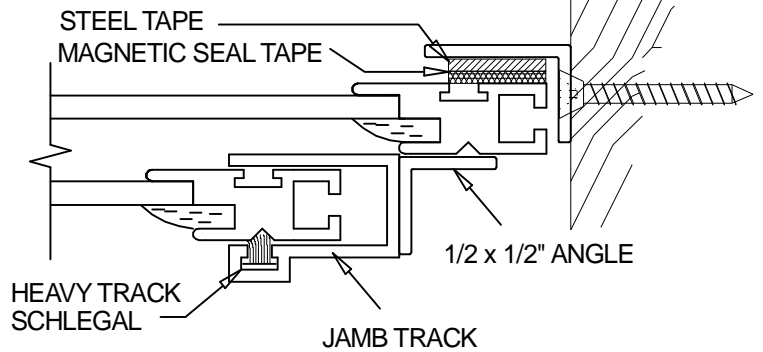

2 JAMB DETAIL
SCALE: FULL

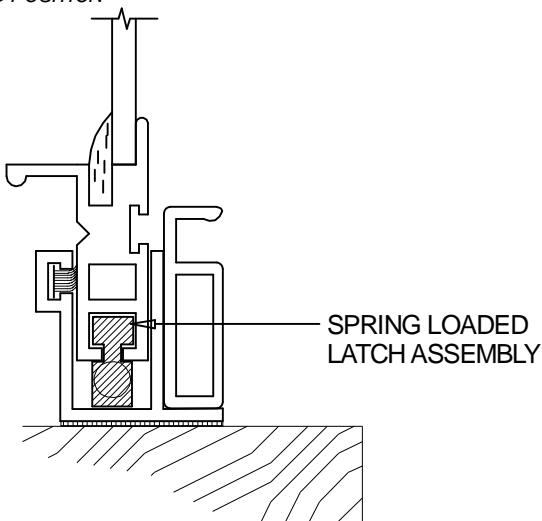

3 SILL DETAIL
SCALE: FULL

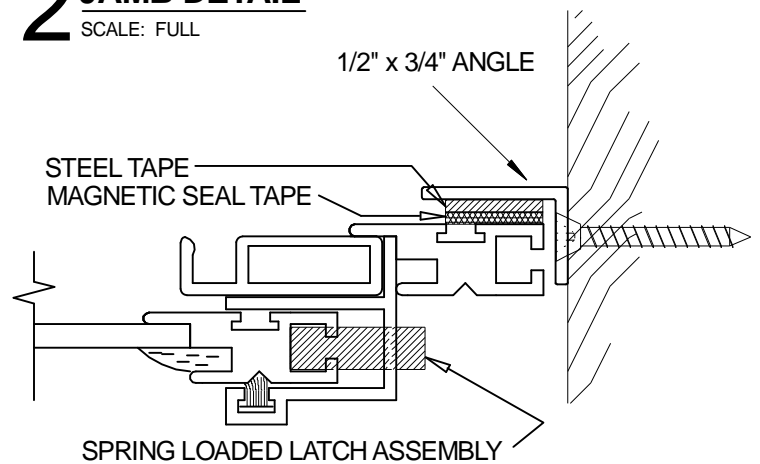

2a JAMB DETAIL
SCALE: FULL

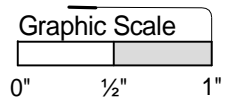

PRODUCT
MAGNETIC ONE LITE, OPERATING MOL-OP
(NO SCREEN) NESTED IN ANGLE

DWG. NO.
M-4-N

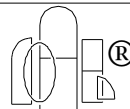

Allied Window
Performance Panels®

11111 CANAL ROAD • CINCINNATI, OH 45241 • PH: 800-445-5411, 513-559-1212 • FAX: 513-559-1883 • www.alliedwindow.com • info@alliedwindow.com

1/28/15 Master Copy